

## Silicon carbide Power MOSFET: 45 A, 1200 V, 90 mΩ (typ., T<sub>J</sub>=150 °C), N-channel in HiP247™

Datasheet - production data

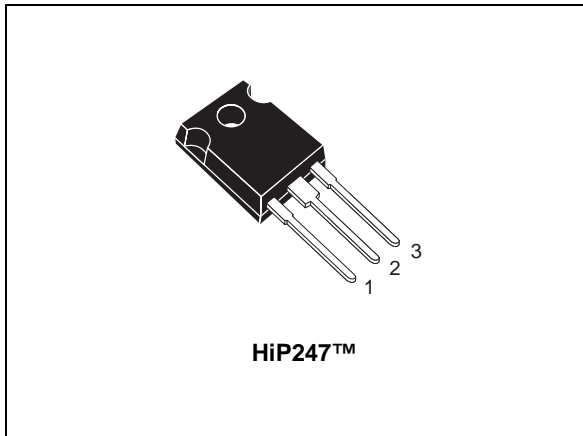
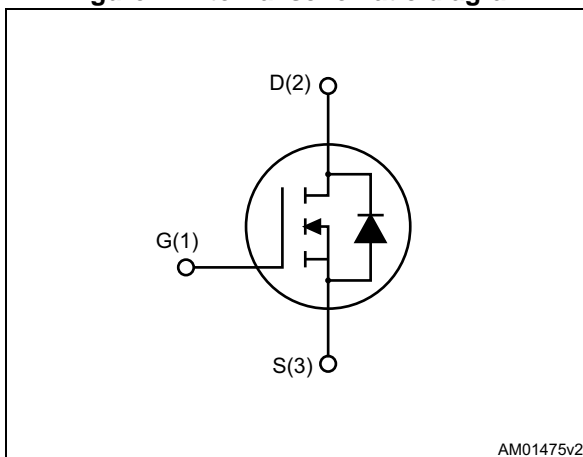

Figure 1. Internal schematic diagram



### Features

- Very tight variation of on-resistance vs. temperature
- Slight variation of switching losses vs. temperature
- Very high operating temperature capability (200 °C)
- Very fast and robust intrinsic body diode
- Low capacitance
- Easy to drive

### Applications

- Solar inverters, UPS
- Motor drives
- High voltage DC-DC converters
- Switch mode power supply

### Description

This silicon carbide Power MOSFET is produced exploiting the advanced, innovative properties of wide bandgap materials. This results in unsurpassed on-resistance per unit area and very good switching performance almost independent of temperature. The outstanding thermal properties of the SiC material, combined with the device's housing in the proprietary HiP247™ package, allows designers to use an industry-standard outline with significantly improved thermal capability. These features render the device perfectly suitable for high-efficiency and high power density applications.

Table 1. Device summary

Order code	Marking	Package	Packaging
SCT30N120	SCT30N120	HiP247™	Tube

*Note:* The device meets ECOPACK standards, an environmentally-friendly grade of products commonly referred to as "halogen-free". See [Section 3: Package mechanical data](#).

# Contents

<b>1</b>	<b>Electrical ratings</b> .....	<b>3</b>
<b>2</b>	<b>Electrical characteristics</b> .....	<b>4</b>
	2.1 Electrical characteristics (curves) .....	6
<b>3</b>	<b>Package mechanical data</b> .....	<b>10</b>
<b>4</b>	<b>Revision history</b> .....	<b>12</b>

# 1 Electrical ratings

**Table 2. Absolute maximum ratings**

Symbol	Parameter	Value	Unit
$V_{DS}$	Drain-source voltage	1200	V
$V_{GS}$	Gate-source voltage	-10/+25	V
$I_D$	Drain current (continuous) at $T_C = 25\text{ °C}$ (limited by die)	45	A
$I_D$	Drain current (continuous) at $T_C = 25\text{ °C}$ (limited by package)	40	A
$I_D$	Drain current (continuous) at $T_C = 100\text{ °C}$	34	A
$I_{DM}^{(1)}$	Drain current (pulsed)	90	A
$P_{TOT}$	Total dissipation at $T_C = 25\text{ °C}$	270	W
$T_{stg}$	Storage temperature	-55 to 200	°C
$T_j$	Operating junction temperature		°C

1. Pulse width limited by safe operating area.

**Table 3. Thermal data**

Symbol	Parameter	Value	Unit
Rthj-case	Thermal resistance junction-case max	0.65	°C/W
Rthj-amb	Thermal resistance junction-ambient max	40	°C/W

## 2 Electrical characteristics

( $T_{CASE} = 25\text{ °C}$  unless otherwise specified).

**Table 4. On/off states**

Symbol	Parameter	Test conditions	Min.	Typ.	Max.	Unit
$I_{DSS}$	Zero gate voltage drain current ( $V_{GS} = 0$ )	$V_{DS} = 1200\text{ V}$		1	100	$\mu\text{A}$
		$V_{DS} = 1200\text{ V}, T_J = 200\text{ °C}$		50		$\mu\text{A}$
$I_{GSS}$	Gate-body leakage current ( $V_{DS} = 0$ )	$V_{GS} = +22 / -10\text{ V}$			100	nA
$V_{GS(th)}$	Gate threshold voltage	$V_{DS} = V_{GS}, I_D = 1\text{ mA}$	1.8	3.5		V
$R_{DS(on)}$	Static drain-source on- resistance	$V_{GS} = 20\text{ V}, I_D = 20\text{ A}$		80	100	m $\Omega$
		$V_{GS} = 20\text{ V}, I_D = 20\text{ A}, T_J = 150\text{ °C}$		90		m $\Omega$
		$V_{GS} = 20\text{ V}, I_D = 20\text{ A}, T_J = 200\text{ °C}$		100		m $\Omega$

**Table 5. Dynamic**

Symbol	Parameter	Test conditions	Min.	Typ.	Max.	Unit
$C_{iss}$	Input capacitance		-	1700	-	pF
$C_{oss}$	Output capacitance	$V_{DS} = 400\text{ V}, f = 1\text{ MHz}, V_{GS} = 0$	-	130	-	pF
$C_{riss}$	Reverse transfer capacitance		-	25	-	pF
$Q_g$	Total gate charge		-	105	-	nC
$Q_{gs}$	Gate-source charge	$V_{DD} = 800\text{ V}, I_D = 20\text{ A}, V_{GS} = 0 / 20\text{ V}$	-	16	-	nC
$Q_{gd}$	Gate-drain charge		-	40	-	nC
$R_g$	Gate input resistance	f=1 MHz open drain	-	5	-	$\Omega$

Table 6. Switching energy (inductive load)

Symbol	Parameter	Test conditions	Min.	Typ.	Max.	Unit
$E_{on}$	Turn-on switching losses	$V_{DD} = 800\text{ V}$ , $I_D = 20\text{ A}$	-	500	-	$\mu\text{J}$
$E_{off}$	Turn-off switching losses	$R_G = 6.8\ \Omega$ , $V_{GS} = -2/20\text{ V}$	-	350	-	$\mu\text{J}$
$E_{on}$	Turn-on switching losses	$V_{DD} = 800\text{ V}$ , $I_D = 20\text{ A}$	-	500	-	$\mu\text{J}$
$E_{off}$	Turn-off switching losses	$R_G = 6.8\ \Omega$ , $V_{GS} = -2/20\text{ V}$ $T_J = 150\text{ }^\circ\text{C}$	-	400	-	$\mu\text{J}$

Table 7. Switching times

Symbol	Parameter	Test conditions	Min.	Typ.	Max.	Unit
$t_{d(on)V}$	Turn-on delay time	$V_{DD} = 800\text{ V}$ , $I_D = 20\text{ A}$ , $R_G = 0\ \Omega$ , $V_{GS} = 0/20\text{ V}$	-	19	-	ns
$t_f(V)$	Fall time		-	28	-	ns
$t_{d(off)V}$	Turn-off delay time		-	45	-	ns
$t_r(V)$	Rise time		-	20	-	ns

Table 8. Reverse SiC diode characteristics

Symbol	Parameter	Test conditions	Min	Typ.	Max	Unit
$V_{SD}$	Diode forward voltage	$I_F = 10\text{ A}$ , $V_{GS} = 0$	-	3.5	-	V
$t_{rr}$	Reverse recovery time	$I_{SD} = 20\text{ A}$ , $di/dt = 100\text{ A}/\mu\text{s}$ $V_{DD} = 800\text{ V}$	-	140	-	ns
$Q_{rr}$	Reverse recovery charge		-	140	-	nC
$I_{RRM}$	Reverse recovery current		-	2	-	A

## 2.1 Electrical characteristics (curves)

Figure 2. Safe operating area

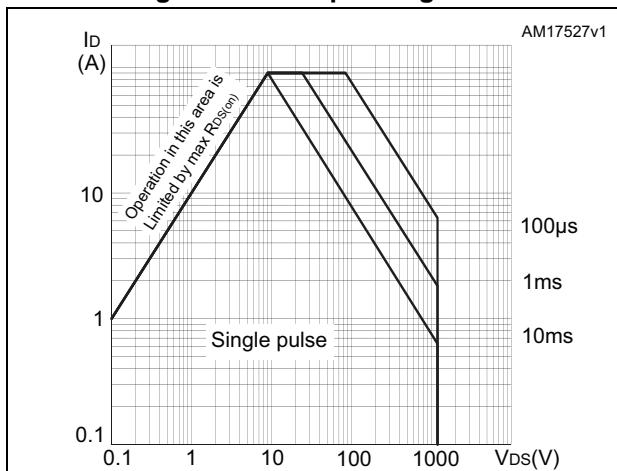

Figure 3. Thermal impedance

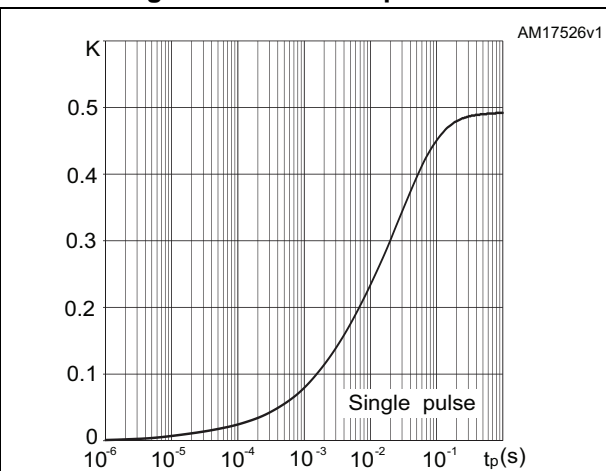

Figure 4. Output characteristics ( $T_J=25^\circ\text{C}$ )

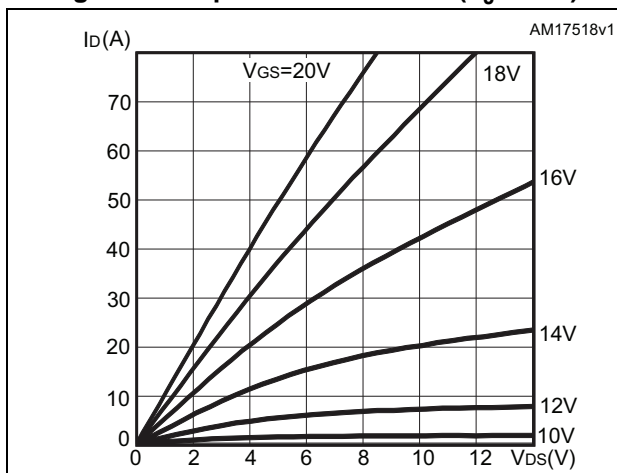

Figure 5. Output characteristics ( $T_J=150^\circ\text{C}$ )

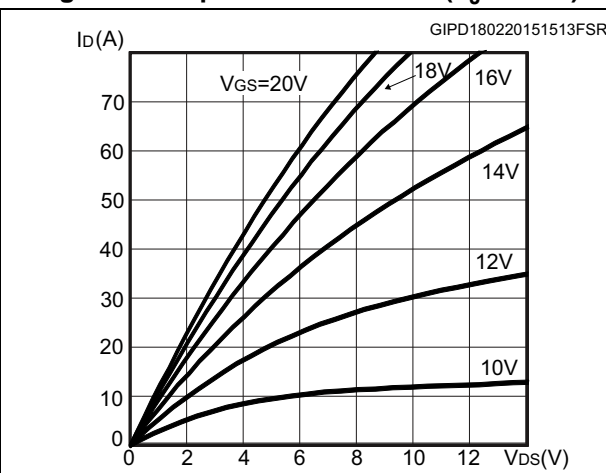

Figure 6. Output characteristics ( $T_J=200^\circ\text{C}$ )

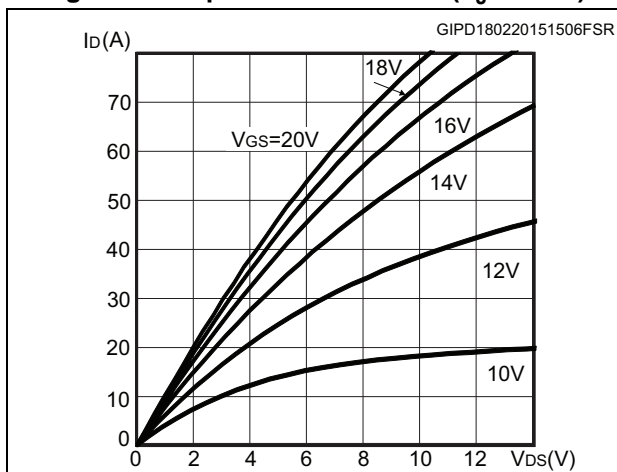

Figure 7. Transfer characteristics

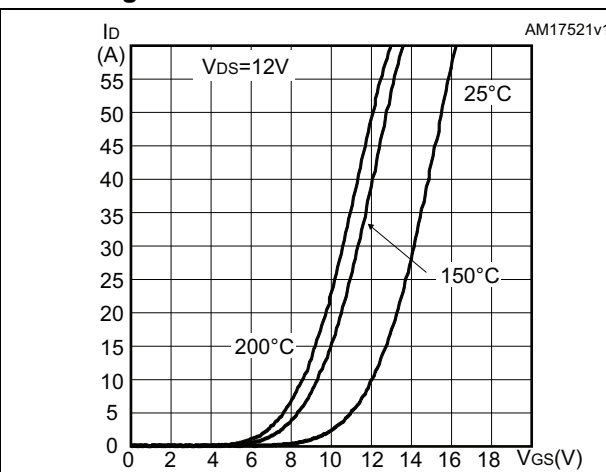

Figure 8. Power dissipation

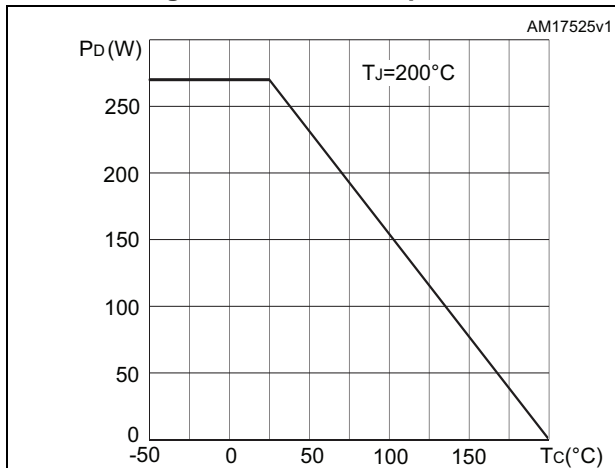

Figure 9. Gate charge vs gate-source voltage

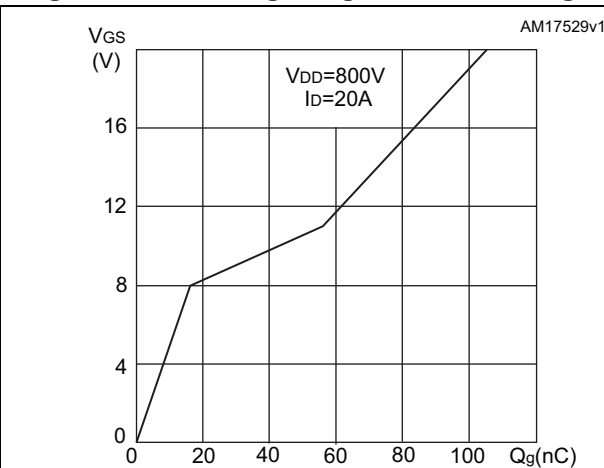

Figure 10. Capacitance variations

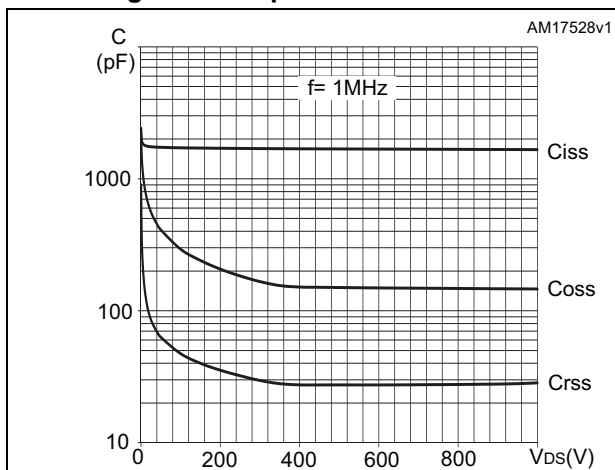

Figure 11. Switching energy vs. drain current

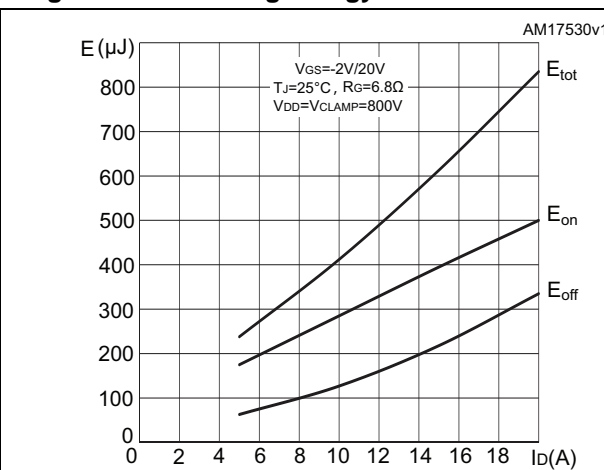

Figure 12. Switching energy vs. junction temperature

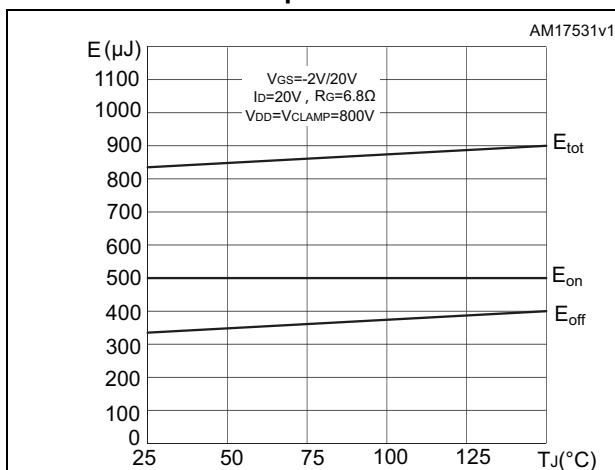

Figure 13. Normalized  $V_{(BR)DSS}$  vs. temperature

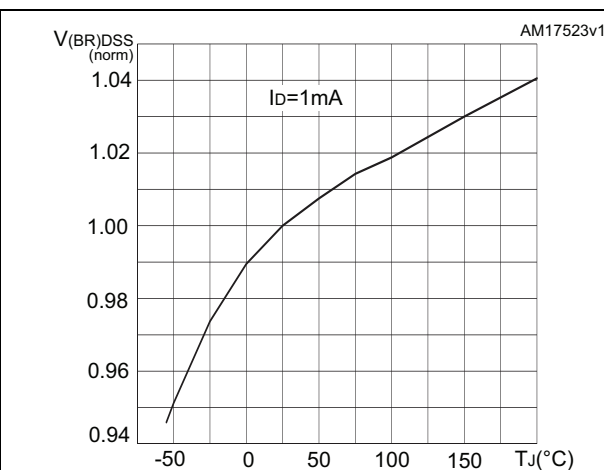

Figure 14. Normalized gate threshold voltage vs. temperature

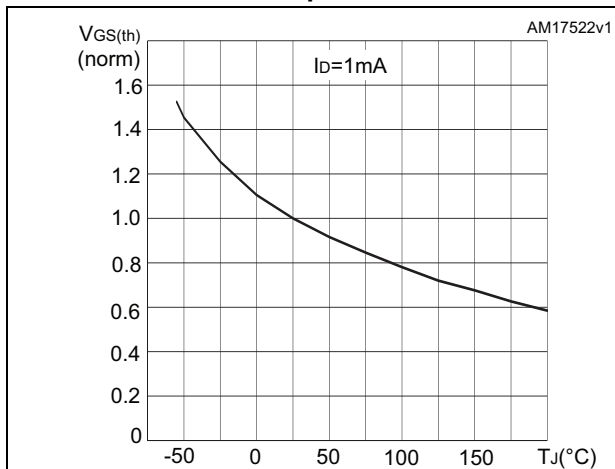

Figure 15. Normalized on-resistance vs. temperature

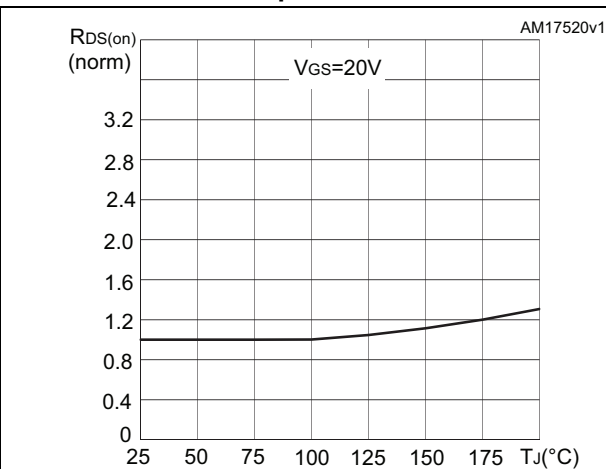

Figure 16. Body diode characteristics ( $T_J = -50^\circ\text{C}$ )

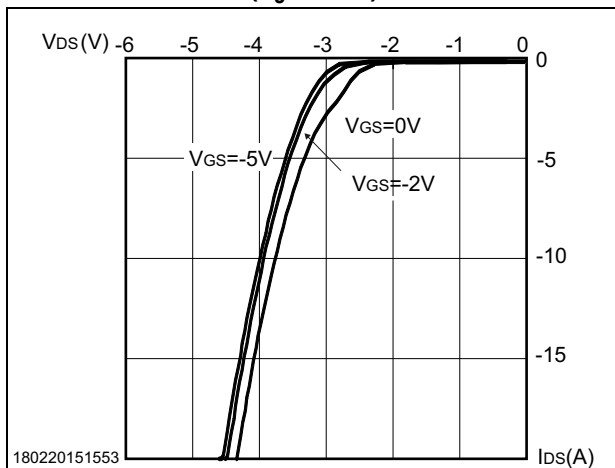

Figure 17. Body diode characteristics ( $T_J = 25^\circ\text{C}$ )

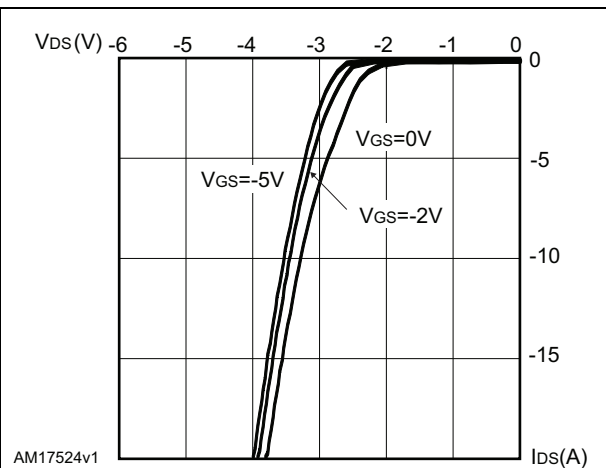

Figure 18. Body diode characteristics ( $T_J = 150^\circ\text{C}$ )

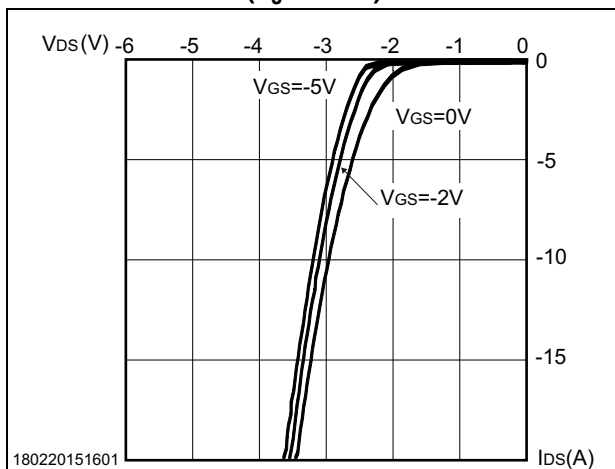

Figure 19. 3<sup>rd</sup> quadrant characteristics ( $T_J = -50^\circ\text{C}$ )

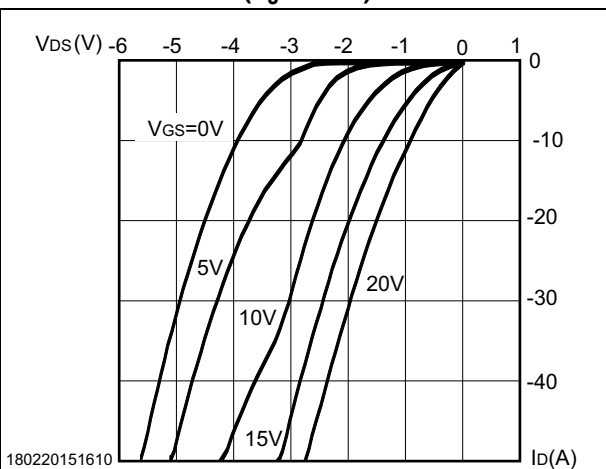



Figure 20. 3<sup>rd</sup> quadrant characteristics (T<sub>J</sub>=25°C)

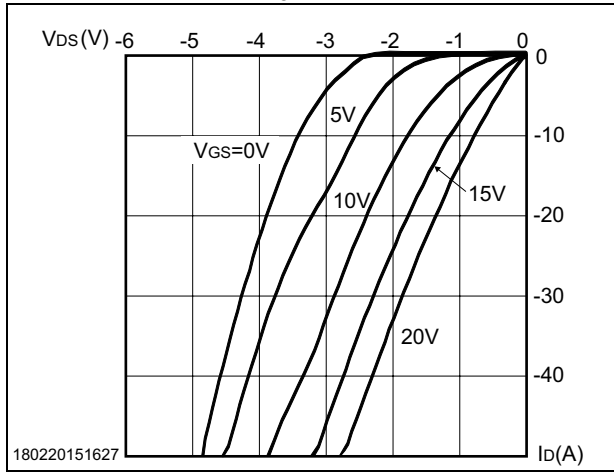
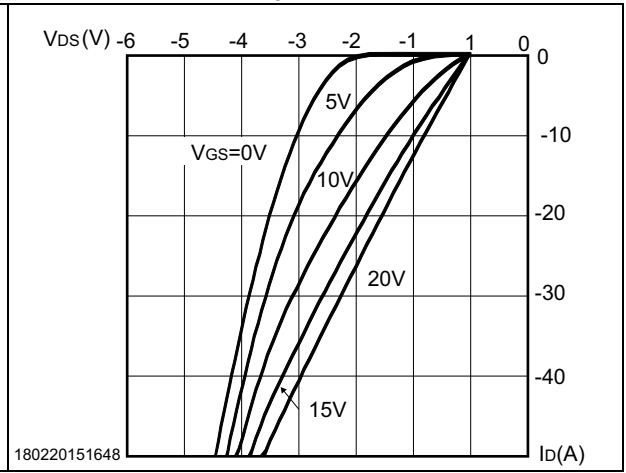

Figure 21. 3<sup>rd</sup> quadrant characteristics (T<sub>J</sub>=150°C)



### 3 Package mechanical data

In order to meet environmental requirements, ST offers these devices in different grades of ECOPACK® packages, depending on their level of environmental compliance. ECOPACK® specifications, grade definitions and product status are available at: [www.st.com](http://www.st.com). ECOPACK® is an ST trademark.

Figure 22. HiP247™ outline

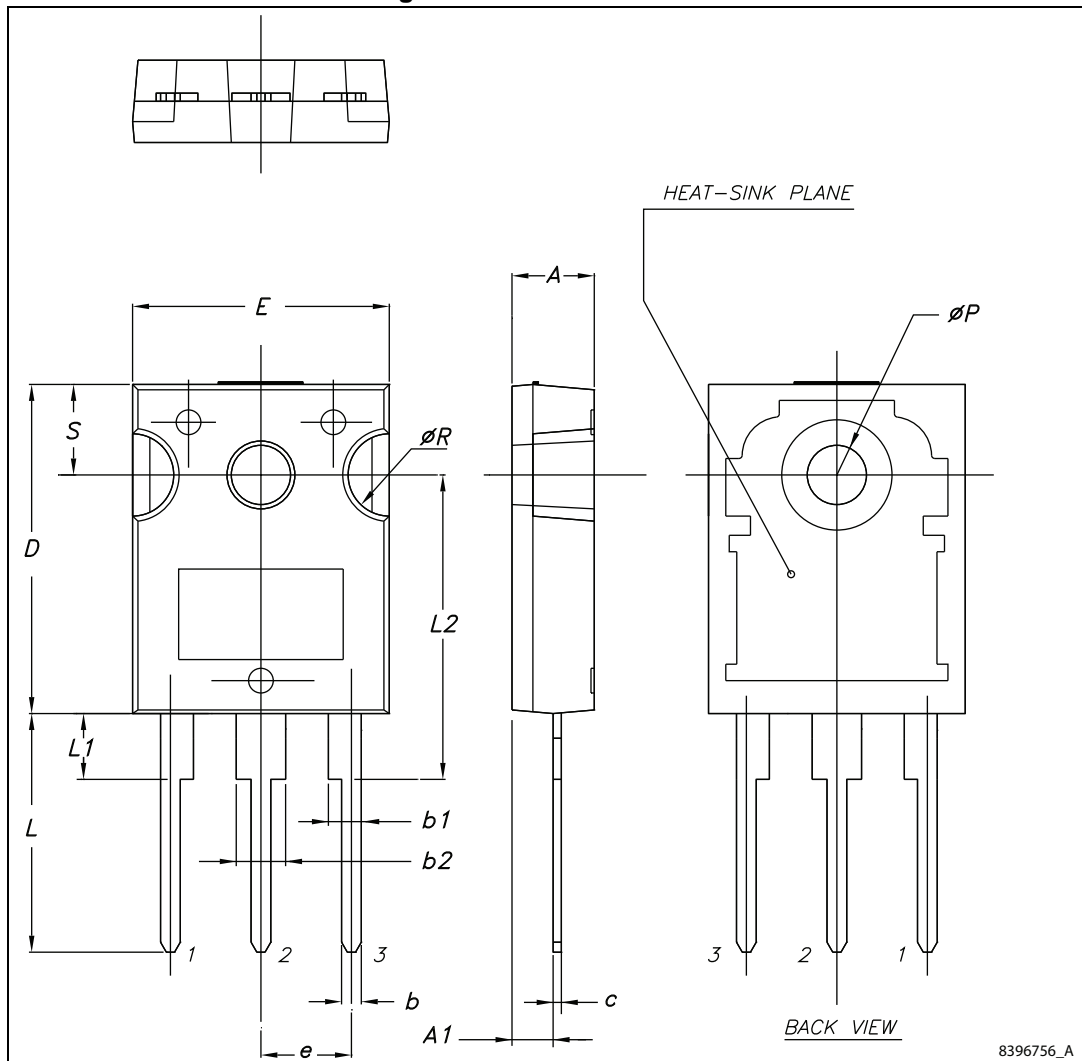

Table 9. HiP247™ mechanical data

Dim.	mm.		
	Min.	Typ.	Max.
A	4.85		5.15
A1	2.20		2.60
b	1.0		1.40
b1	2.0		2.40
b2	3.0		3.40
c	0.40		0.80
D	19.85		20.15
E	15.45		15.75
e	5.30	5.45	5.60
L	14.20		14.80
L1	3.70		4.30
L2		18.50	
ØP	3.55		3.65
ØR	4.50		5.50
S	5.30	5.50	5.70

## 4 Revision history

**Table 10. Document revision history**

Date	Revision	Changes
10-May-2012	1	First release
21-May-2013	2	Updated $t_{rr}$ value in <a href="#">Table 8</a> . Updated dynamic parameters in <a href="#">Table 5</a> , $V_{GS(th)}$ in <a href="#">Table 4</a> and $E_{on}$ in <a href="#">Table 6</a> .
24-Jun-2013	3	Document status promoted from target to preliminary data. Added: <a href="#">Section 2.1: Electrical characteristics (curves)</a>
11-Jul-2013	4	Updated <a href="#">Figure 6: Output characteristics (<math>T_J=200^{\circ}C</math>)</a> and <a href="#">Figure 7: Transfer characteristics</a> .
18-Dec-2013	5	Updated parameters in <a href="#">Table 2: Absolute maximum ratings</a> and <a href="#">Table 4: On/off states</a> .
27-May-2014	6	Added <a href="#">Table 7: Switching times</a> . Updated <a href="#">Section 3: Package mechanical data</a> . Minor text changes.
25-Sep-2014	7	Document status promoted from preliminary to production data.
17-Feb-2015	8	Updated title in cover page.
20-Feb-2015	9	Updated <a href="#">Section 2.1: Electrical characteristics (curves)</a> .

**IMPORTANT NOTICE – PLEASE READ CAREFULLY**

STMicroelectronics NV and its subsidiaries ("ST") reserve the right to make changes, corrections, enhancements, modifications, and improvements to ST products and/or to this document at any time without notice. Purchasers should obtain the latest relevant information on ST products before placing orders. ST products are sold pursuant to ST's terms and conditions of sale in place at the time of order acknowledgement.

Purchasers are solely responsible for the choice, selection, and use of ST products and ST assumes no liability for application assistance or the design of Purchasers' products.

No license, express or implied, to any intellectual property right is granted by ST herein.

Resale of ST products with provisions different from the information set forth herein shall void any warranty granted by ST for such product.

ST and the ST logo are trademarks of ST. All other product or service names are the property of their respective owners.

Information in this document supersedes and replaces information previously supplied in any prior versions of this document.

© 2015 STMicroelectronics – All rights reserved

# Mouser Electronics

Authorized Distributor

Click to View Pricing, Inventory, Delivery & Lifecycle Information:

[STMicroelectronics:](#)

[SCT30N120](#)